

IR Receiver Modules for Remote Control Systems

Description

The HS0038A2 is a miniaturized receiver for infrared remote control systems. A PIN diode and a preamplifier are assembled on a lead frame, the epoxy package acts as an IR filter.

The demodulated output signal can be directly decoded by a microprocessor. The HS0038A2 is compatible with all common IR remote control data formats.

This component has not been qualified according to automotive specifications.

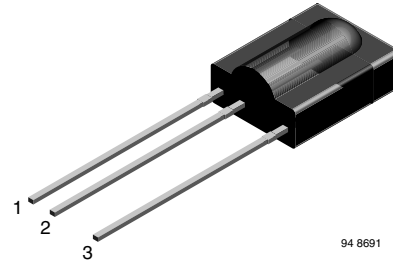

Features

- Very low supply current
- Photo detector and preamplifier in one package
- Internal filter for PCM frequency
- Improved shielding against EMI
- Supply voltage: 2.5 V to 5.5 V
- Improved immunity against ambient light
- Component in accordance to RoHS 2002/95/EC and WEEE 2002/96/EC
- Insensitive to supply voltage ripple and noise



Mechanical Data

Pinning:

1 = GND, 2 = V_S , 3 = OUT

Block Diagram

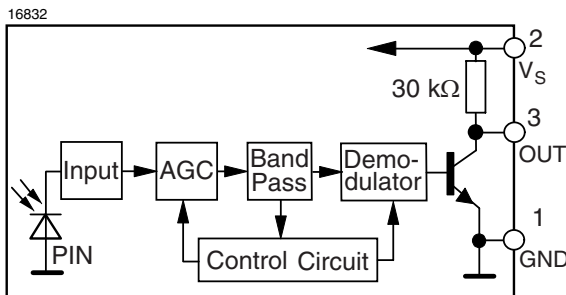

Application Circuit

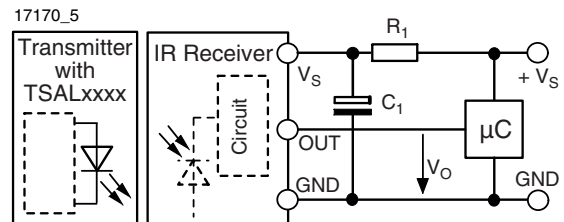

R_1 and C_1 are recommended for protection against EOS. Components should be in the range of $33 \Omega < R_1 < 1 \text{ k}\Omega$, $C_1 > 0.1 \mu\text{F}$.

Absolute Maximum Ratings

Stresses beyond those listed under "Absolute Maximum Ratings" may cause permanent damage to the device. This is a stress rating only and functional operation of the device at these or any other conditions beyond those indicated in the operational sections of this specification is not implied. Exposure to absolute maximum rating conditions for extended periods may affect the device reliability.

Parameter	Test condition	Symbol	Value	Unit
Supply voltage (pin 2)		V_S	- 0.3 to + 6.0	V
Supply current (pin 2)		I_S	3	mA
Output voltage (pin 3)		V_O	- 0.3 to ($V_S + 0.3$)	V
Output current (pin 3)		I_O	5	mA
Junction temperature		T_j	100	°C
Storage temperature range		T_{stg}	- 25 to + 85	°C
Operating temperature range		T_{amb}	- 25 to + 85	°C
Power consumption	($T_{amb} \leq 85$ °C)	P_{tot}	10	mW
Soldering temperature	$t \leq 10$ s, 1 mm from case	T_{sd}	260	°C

Electrical and Optical Characteristics

$T_{amb} = 25$ °C, unless otherwise specified

Parameter	Test condition	Symbol	Min.	Typ.	Max.	Unit
Supply current (pin 2)	$E_v = 0, V_S = 3.3$ V	I_{SD}	0.27	0.35	0.45	mA
	$E_v = 40$ klx, sunlight	I_{SH}		0.45		mA
Supply voltage		V_S	2.5		5.5	V
Transmission distance	$E_v = 0$, test signal see fig. 1, IR diode TSAL6200, $I_F = 250$ mA	d		45		m
Output voltage low (pin 3)	$I_{OSL} = 0.5$ mA, $E_e = 0.7$ mW/m ² , test signal see fig. 1	V_{OSL}			100	mV
Minimum irradiance	Pulse width tolerance: $t_{pi} - 5/f_0 < t_{po} < t_{pi} + 6/f_0$, test signal see fig. 1	$E_{e\ min}$		0.15	0.35	mW/m ²
Maximum irradiance	$t_{pi} - 5/f_0 < t_{po} < t_{pi} + 6/f_0$, test signal see fig. 1	$E_{e\ max}$	30			W/m ²
Directivity	Angle of half transmission distance	$\phi_{1/2}$		± 45		deg

Typical Characteristics

$T_{amb} = 25$ °C, unless otherwise specified

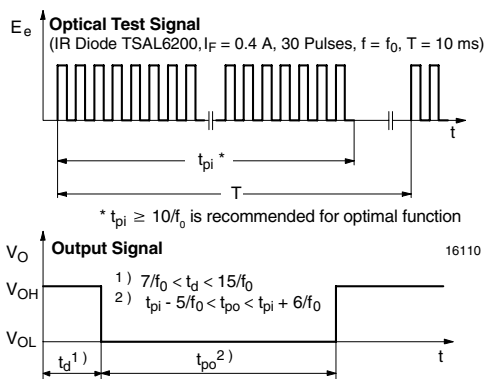

Figure 1. Output Active Low

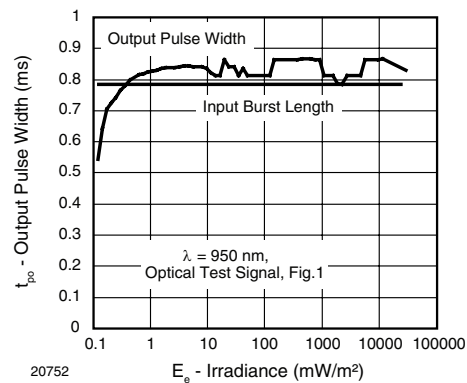

Figure 2. Pulse Length and Sensitivity in Dark Ambient

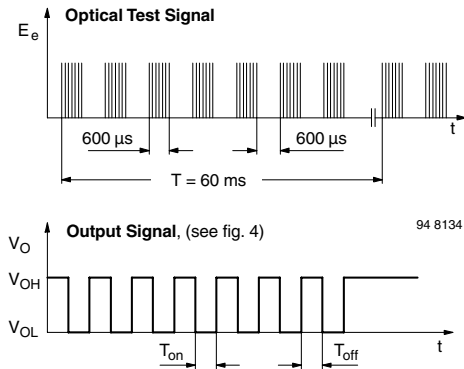

Figure 3. Output Function

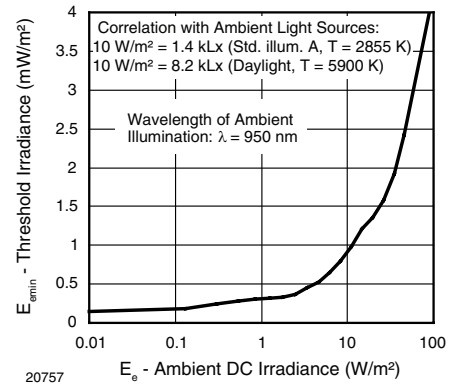

Figure 6. Sensitivity in Bright Ambient

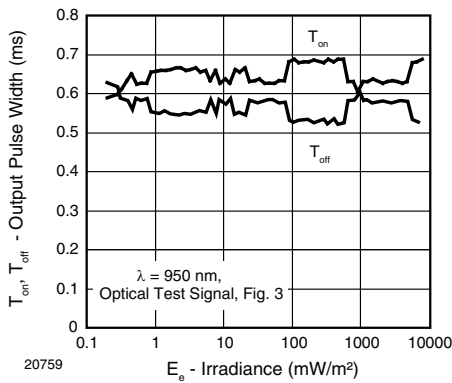

Figure 4. Output Pulse Diagram

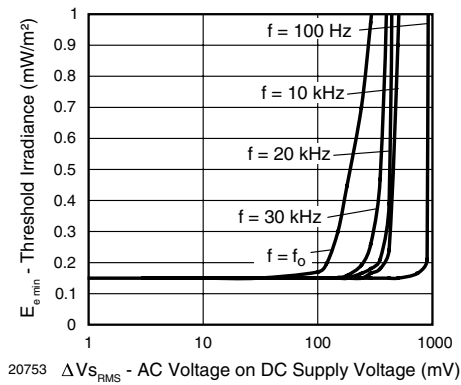

Figure 7. Sensitivity vs. Supply Voltage Disturbances

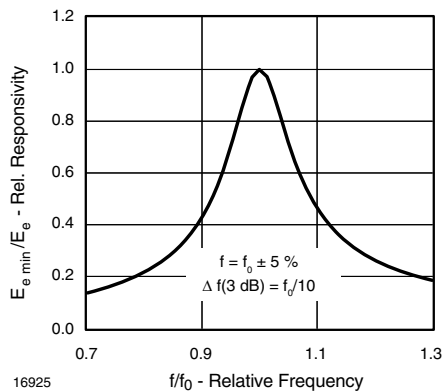

Figure 5. Frequency Dependence of Responsivity

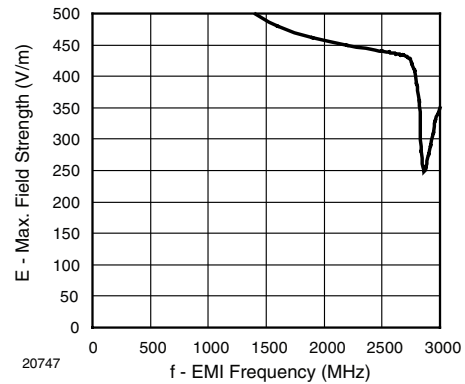

Figure 8. Sensitivity vs. Electric Field Disturbances

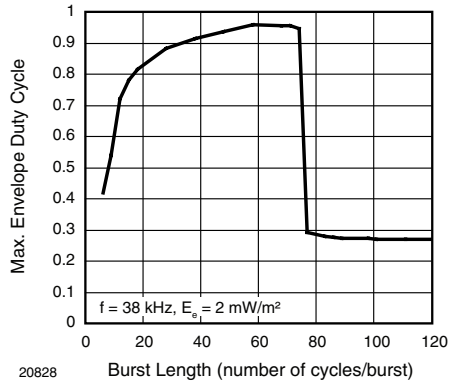

Figure 9. Max. Envelope Duty Cycle vs. Burst Length

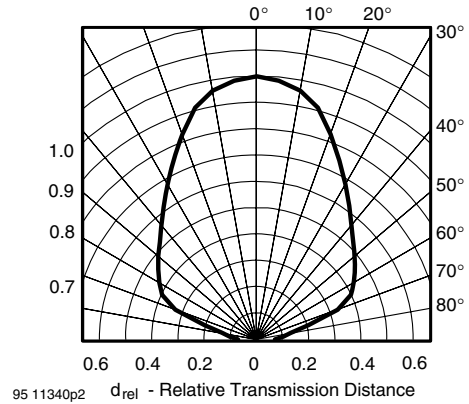

Figure 12. Horizontal Directivity

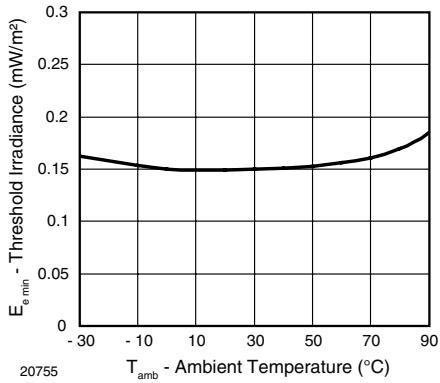

Figure 10. Sensitivity vs. Ambient Temperature

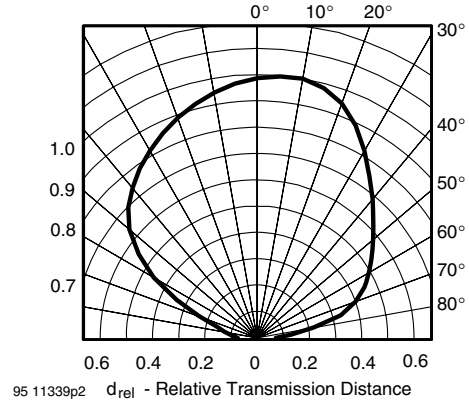

Figure 13. Vertical Directivity

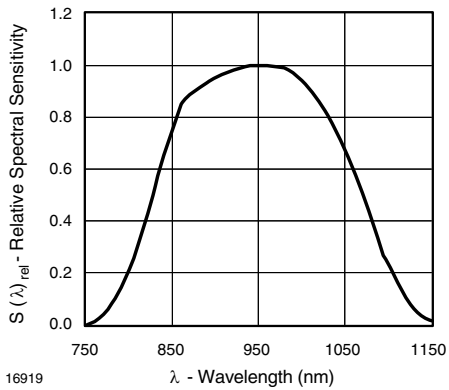

Figure 11. Relative Spectral Sensitivity vs. Wavelength

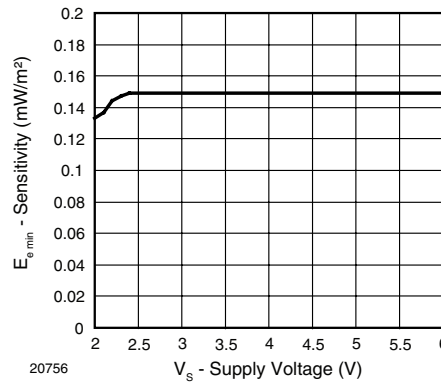

Figure 14. Sensitivity vs. Supply Voltage

Suitable Data Format

The HS0038A2 is designed to suppress spurious output pulses due to noise or disturbance signals. Data and disturbance signals can be distinguished by the devices according to carrier frequency, burst length and envelope duty cycle. The data signal should be close to the band-pass center frequency (e.g. 38 kHz) and fulfill the conditions in the table below.

When a data signal is applied to the HS0038A2 in the presence of a disturbance signal, the sensitivity of the receiver is reduced to insure that no spurious pulses are present at the output. Some examples of disturbance signals which are suppressed are:

- DC light (e.g. from tungsten bulb or sunlight)
- Continuous signals at any frequency
- Strongly or weakly modulated noise from fluorescent lamps with electronic ballasts (see figure 15 or figure 16).

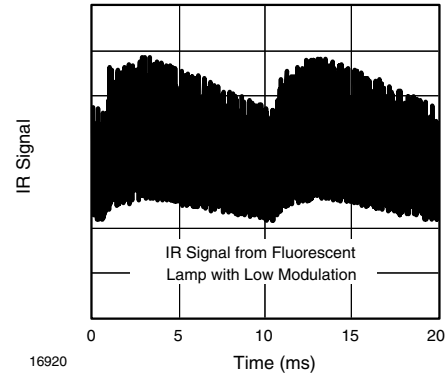

Figure 15. IR Signal from Fluorescent Lamp with Low Modulation

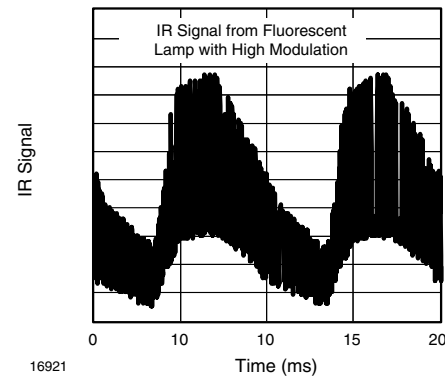
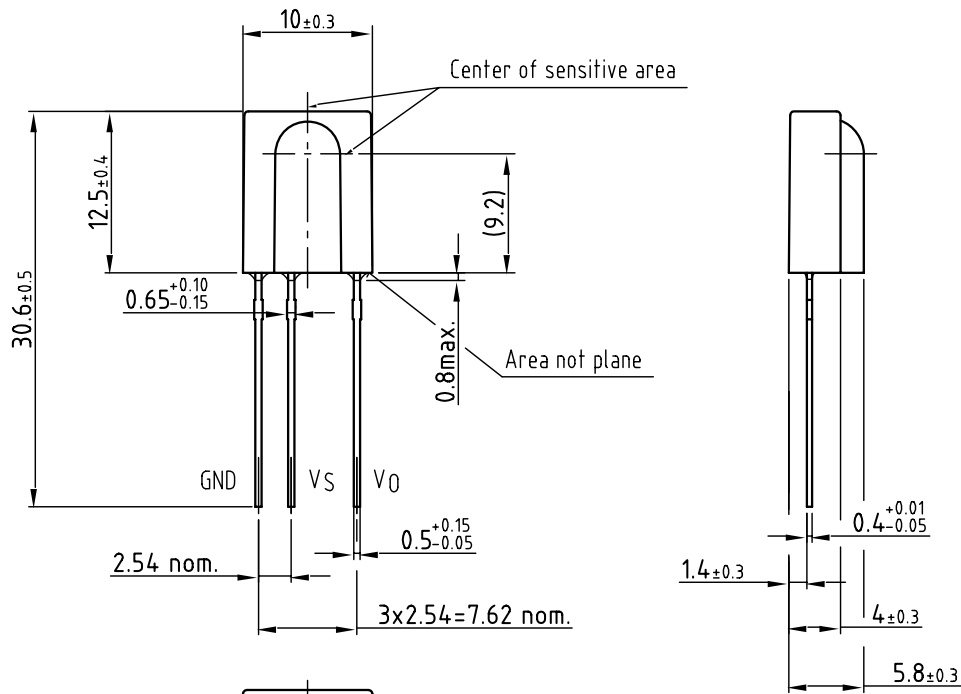

Figure 16. IR Signal from Fluorescent Lamp with High Modulation

	HS0038A2
Minimum burst length	10 cycles/burst
After each burst of length	10 to 70 cycles
A minimum gap time is required of	10 cycles
For bursts greater than	70 cycles
A minimum gap time in the data stream is needed of	> 4 x burst length
Maximum continuous short bursts/second	1800
NEC code (repetitive pulse)	yes
NEC code (repetitive data)	yes
Compatible to RC5/RC6 code	yes
Compatible to Sony code	yes
Compatible to Mitsubishi code (38 kHz, preburst 8 ms, 16 bit)	yes
Compatible to Sharp code	yes
Toshiba Micom format	yes
R-2000 code	yes
And other codes	

Package Dimensions in millimeters



Drawing-No.: 6.550-5095.01-4
Issue: 17; 22.03.04

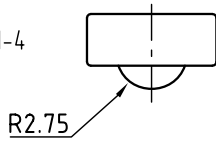

technical drawings
according to DIN
specifications

96 12116



Ozone Depleting Substances Policy Statement

It is the policy of Vishay Semiconductor GmbH to

1. Meet all present and future national and international statutory requirements.
2. Regularly and continuously improve the performance of our products, processes, distribution and operating systems with respect to their impact on the health and safety of our employees and the public, as well as their impact on the environment.

It is particular concern to control or eliminate releases of those substances into the atmosphere which are known as ozone depleting substances (ODSs).

The Montreal Protocol (1987) and its London Amendments (1990) intend to severely restrict the use of ODSs and forbid their use within the next ten years. Various national and international initiatives are pressing for an earlier ban on these substances.

Vishay Semiconductor GmbH has been able to use its policy of continuous improvements to eliminate the use of ODSs listed in the following documents.

1. Annex A, B and list of transitional substances of the Montreal Protocol and the London Amendments respectively.
2. Class I and II ozone depleting substances in the Clean Air Act Amendments of 1990 by the Environmental Protection Agency (EPA) in the USA.
3. Council Decision 88/540/EEC and 91/690/EEC Annex A, B and C (transitional substances) respectively.

Vishay Semiconductor GmbH can certify that our semiconductors are not manufactured with ozone depleting substances and do not contain such substances.

We reserve the right to make changes to improve technical design
and may do so without further notice.

Parameters can vary in different applications. All operating parameters must be validated for each customer application by the customer. Should the buyer use Vishay Semiconductors products for any unintended or unauthorized application, the buyer shall indemnify Vishay Semiconductors against all claims, costs, damages, and expenses, arising out of, directly or indirectly, any claim of personal damage, injury or death associated with such unintended or unauthorized use.

Vishay Semiconductor GmbH, P.O.B. 3535, D-74025 Heilbronn, Germany